

test turnouts

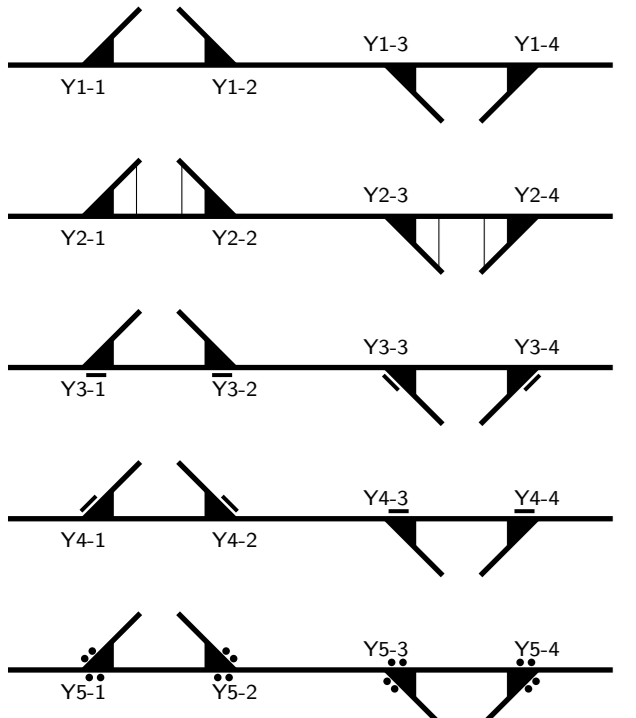

test slip turnouts

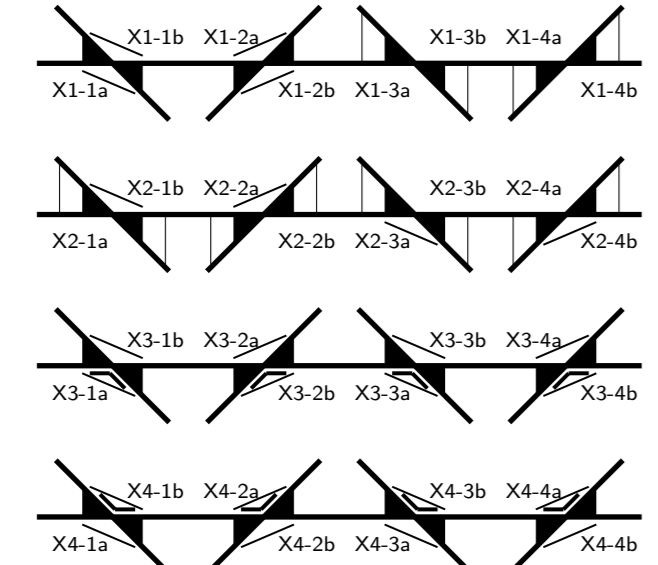

test shunting movements

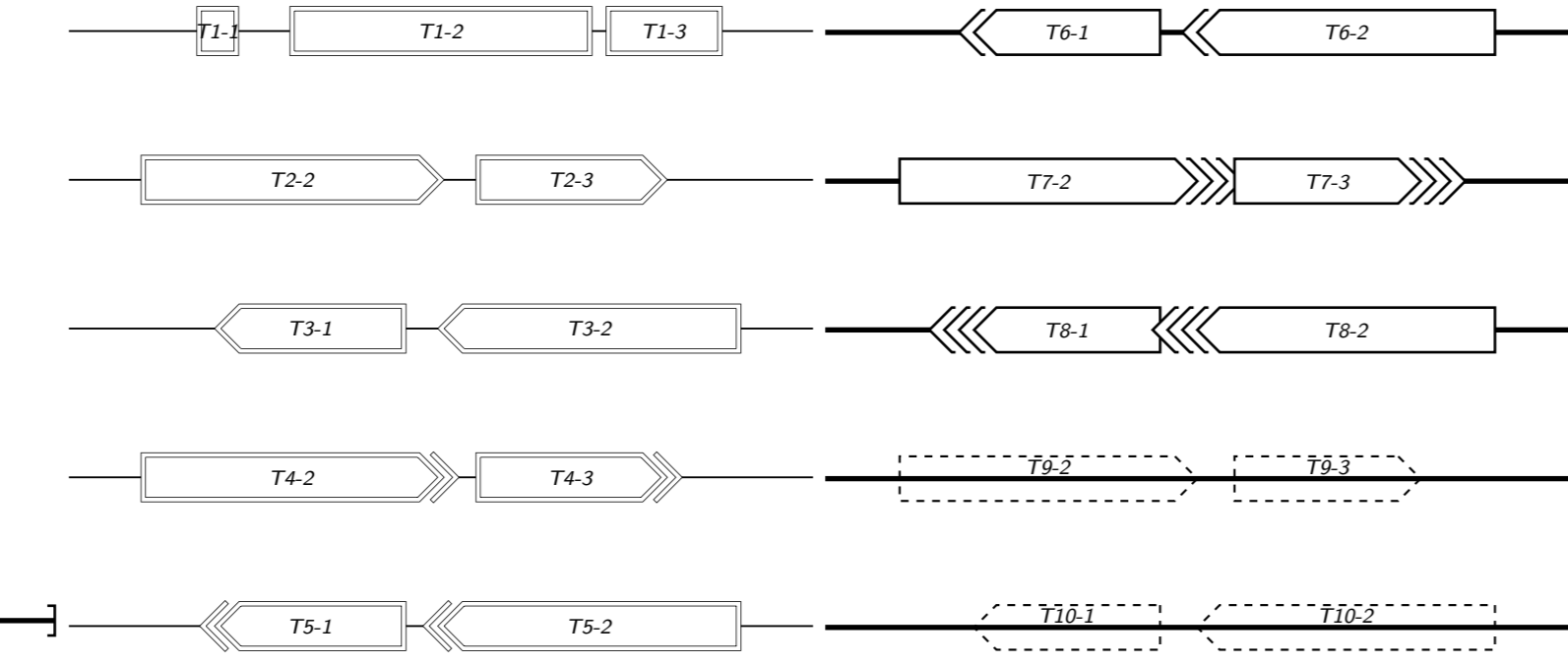

test misc. topology symbols

really long text

22

test train run

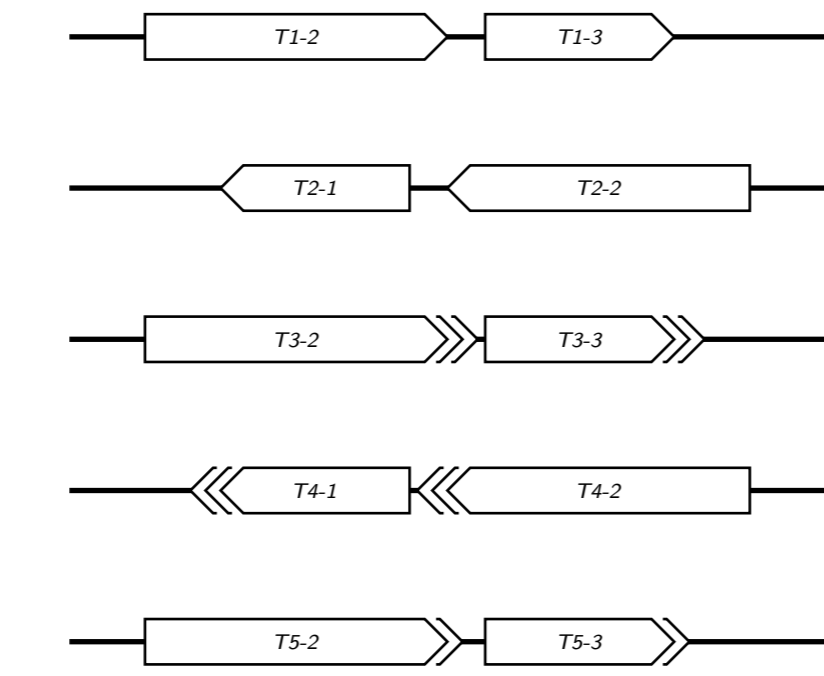

test signal symbols

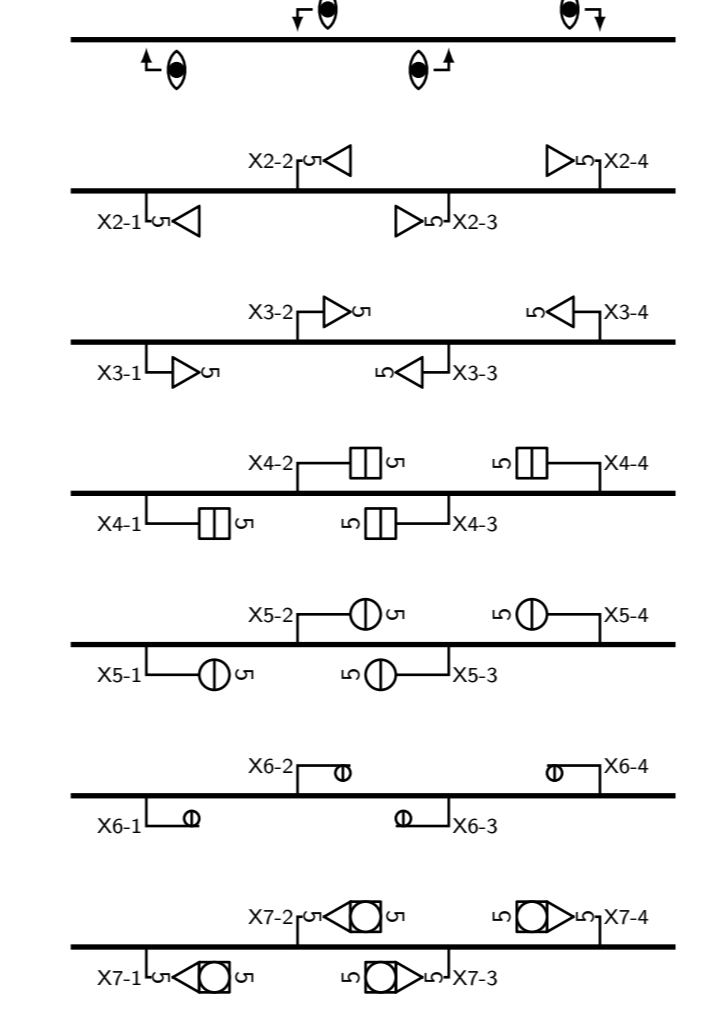

test clearing points symbols

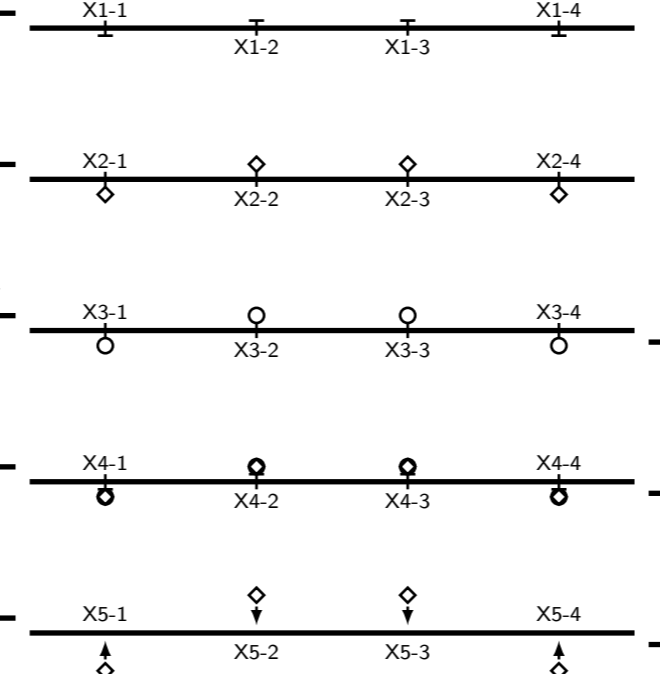

test bend vehicles

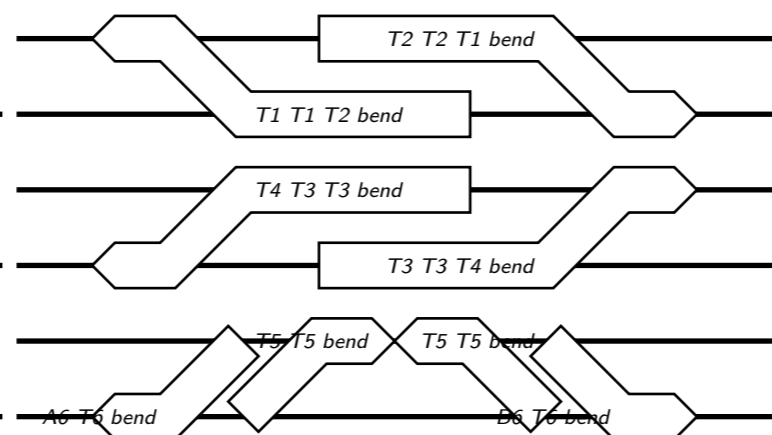

test transmitter symbols

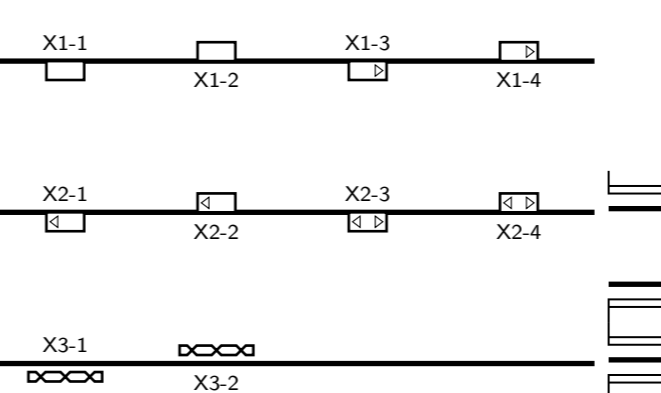

test platform symbols

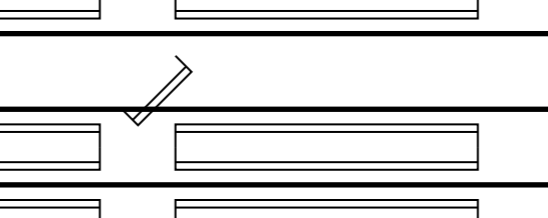

test level crossing symbols

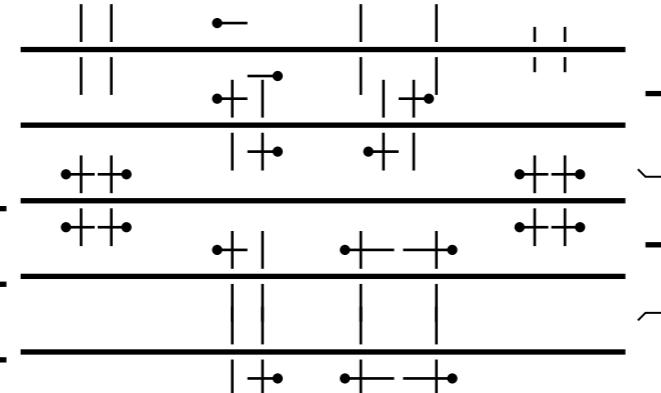

test bridge symbol

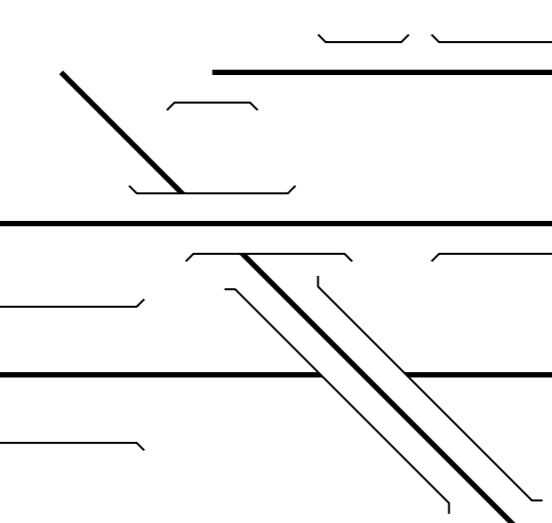

test berth symbols

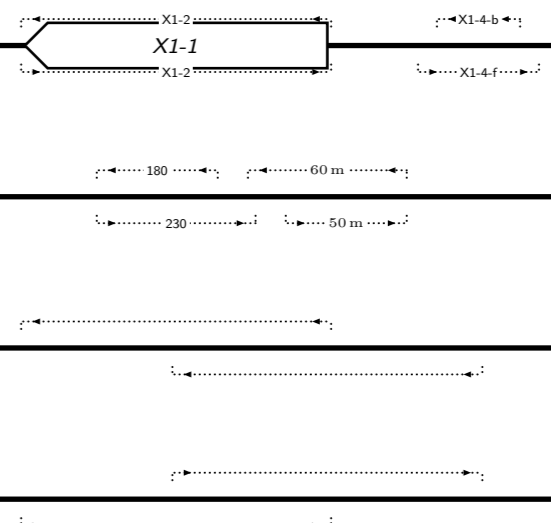

test pylon symbols

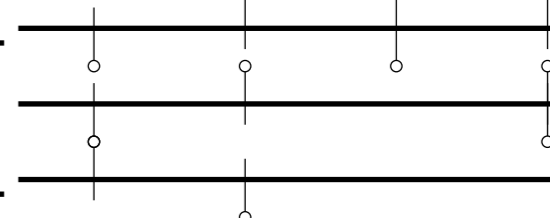

test measure symbols

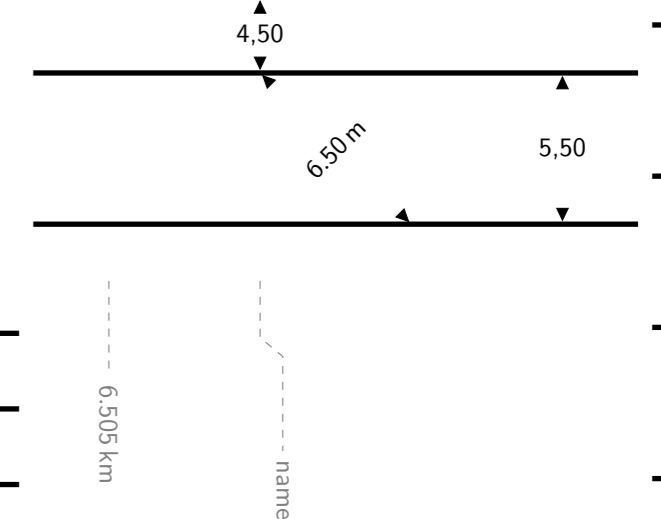

test electric symbols

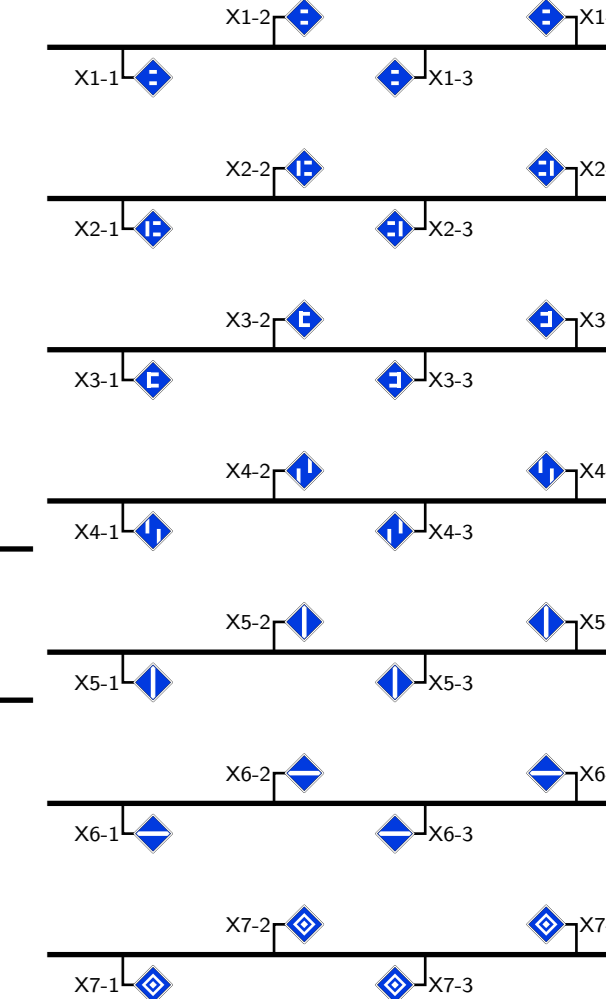

6.505 km

name